

# SLIM PRO

*Minimalist Design*

designed by

*BANHOCONCEPT*

## SLIM PRO

Slim Pro redefine o padrão de elegância e precisão. Dobradiças minimalistas com uma elegância intemporal.

A alteração da barra estabilizadora convencional para uma barra em “L”, transmite uma enorme suavidade no aspeto geral de qualquer modelo.

### Um acabamento de excelência

A Série Slim Pro combina design minimalista com máxima resistência.

Dobradiças em PVD de alta durabilidade, disponíveis em acabamentos Ouro Bronze, Ouro, Cobre e Grafite Escovado, assim como Cromado, Escovado e Preto Mate.

Com linhas finas e acabamento de excelência, a Série Slim Pro eleva-se pelo alto desempenho.

Uma solução distinta, concebida para unir robustez, funcionalidade e design contemporâneo.

### Um novo desenho

A afirmação de design do novo puxador aliado ao vidro temperado extra-claro expõe o minimalismo e classe desta Série Slim Pro.

As dobradiças mais pequenas e elegantes unem-se num cenário de qualidade mantendo o equilíbrio entre forma e função.

### A qualidade de sempre!

Com novas linhas mais discretas a Série Slim Pro mantém a qualidade a que habituamos em todos os nossos projetos.

Focados na capacidade da engenharia, melhoramos as funções de ajuste de fecho, ponto de paragem, acabamentos e ainda o modo de fixação.

Qualidade premium!



# ACABAMENTOS METÁLICOS



BC005  
CROMADO



PVD22  
ESCOVADO

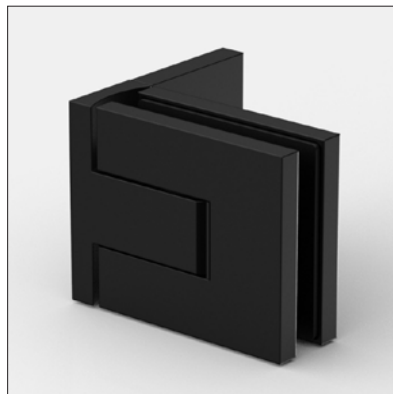

BC135  
PRETO MATE



PVD39  
OURO BRONZE  
ESCOVADO



PVD40  
OURO ESCOVADO

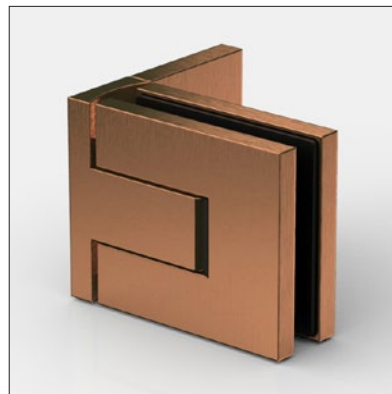

PVD41  
COBRE ESCOVADO



PVD42  
GRAFITE ESCOVADO

## ACABAMENTOS DE VIDRO



EC  
EXTRA-CLARO



VF  
FOSCO



VB  
BRONZE

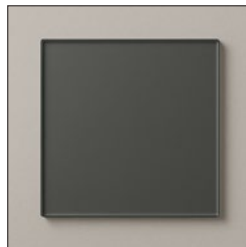

VC  
CINZA



VM  
MIRASTAR



A1  
ÍNTIMA



B1  
BANDA LARGA



B2  
BANDA DUPLA

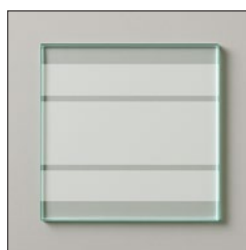

B3  
BANDA TRIPLA



CN  
CANELADO

## PARÂMETROS DA SÉRIE



NOME DA SÉRIE  
**SLIM PRO**

TIPOLOGIA  
**PORTAS DE ABRIR**

TRATAMENTO (VIDRO)  
**TCS 10A**

NORMA (TÊMPERA)  
**EN 12150:2010**

ALTURA (STANDARD)  
**1960MM**

ACABAMENTO (VIDRO)  
**SGG 8MM TEMPERADO**  
EC / VF / VB / VC / VM / A1 / B1 / B2 / B3 / CN

ACABAMENTO (METAL)

**PVD** (Physical Vapor Deposition)  
BC005 / BC135 / PVD22 / PVD39 / PVD40 / PVD41 / PVD42

# SLIM PRO D-401



PAINEL FIXO SIMPLES

# SLIM PRO D-405



LATERAL FIXO + 1 PORTA DE ABRIR

# SLIM PRO D-406



ÂNGULAR: 2 FIXOS + 2 PORTAS DE ABRIR

# SLIM PRO D-407



1 PORTA DE ABRIR

# SLIM PRO D-408



1 FIXO + 1 PORTA DE ABRIR

# SLIM PRO D-409



1 FIXO + 1 PORTA DE ABRIR + LATERAL FIXO

# SLIM PRO D-410



1 FIXO + 1 PORTA DE ABRIR

# SLIM PRO D-411



1 PORTA DE ABRIR + 1 FIXO + LATERAL FIXO

# SLIM PRO D-416



2 FIXOS + 1 PORTA DE ABRIR

# DETALHES TÉCNICOS



## DOBRADIÇA VIDRO-PAREDE 90°

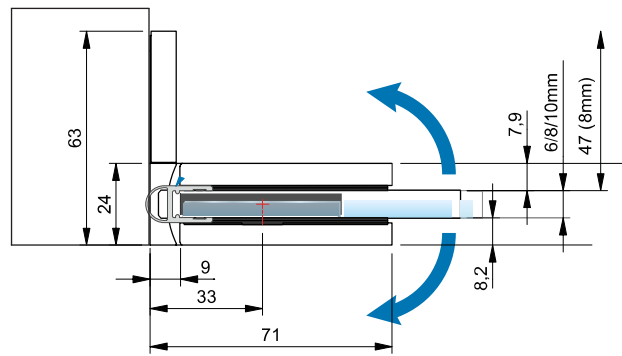
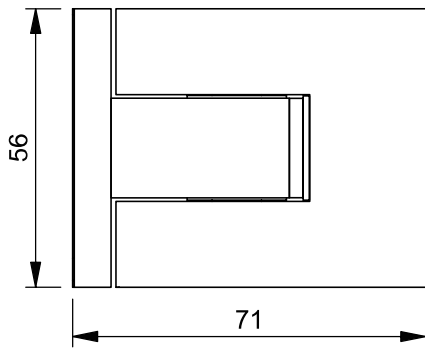

## DOBRADIÇA VIDRO-VIDRO 180°

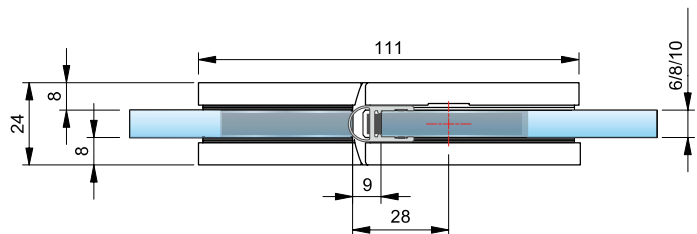
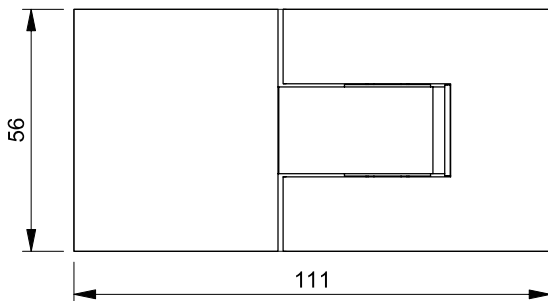

## FIXADOR 90°

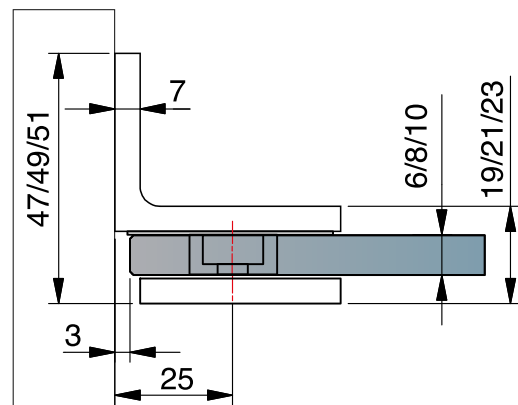
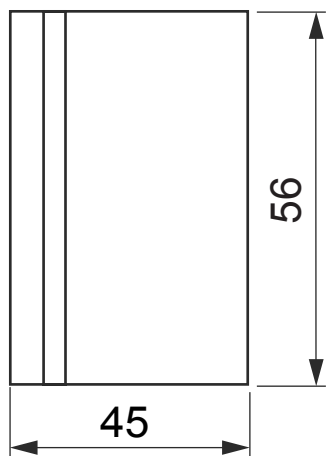

# DETALHES TÉCNICOS

PICTOGRAMAS



## MODELO D-401

(E) esquerdo

(D) direito

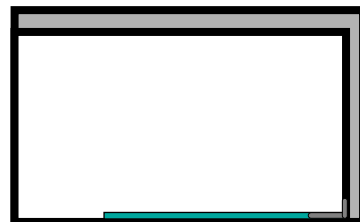
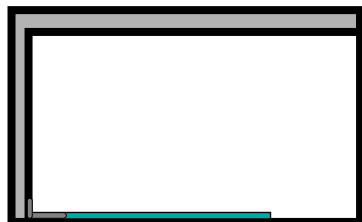

## MODELO D-405

(E) esquerdo

(D) direito

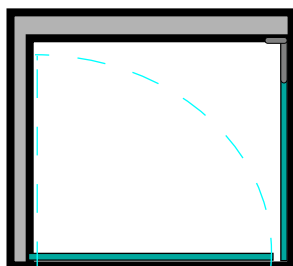
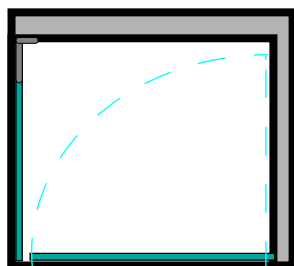

## MODELO D-406

posição

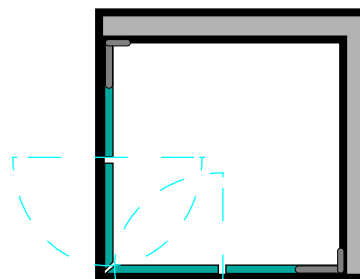

## MODELO D-407

(E) esquerdo

(D) direito

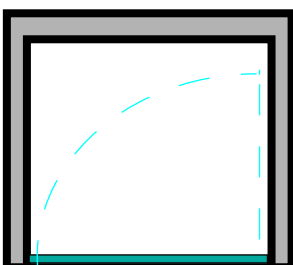
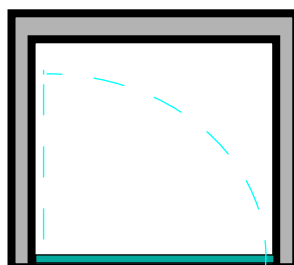

# DETALHES TÉCNICOS

PICTOGRAMAS



## MODELO D-408

(E) esquerdo

(D) direito

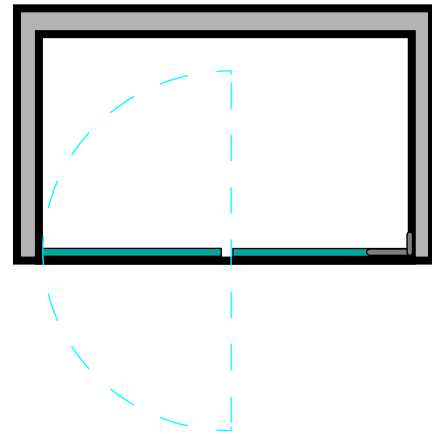
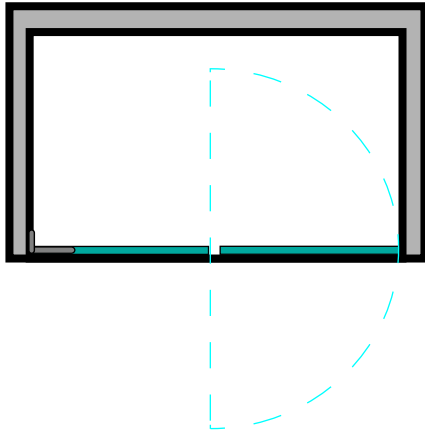

## MODELO D-409

(E) esquerdo

(D) direito

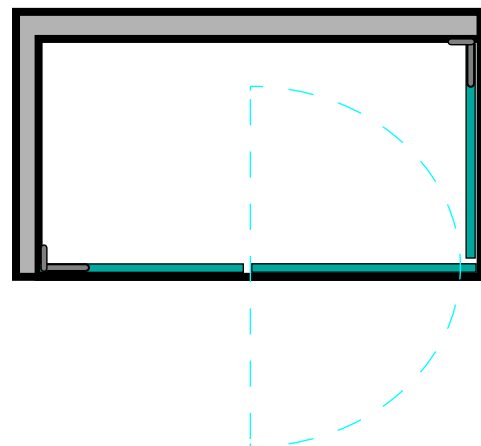
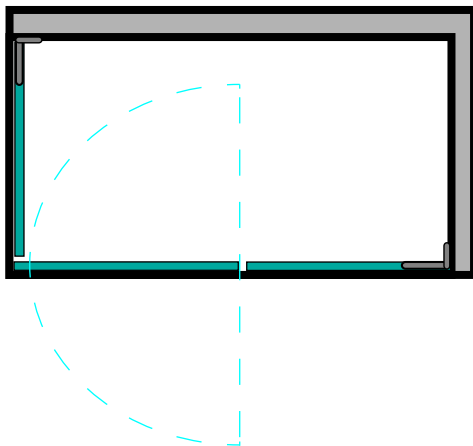

## MODELO D-410

(E) esquerdo

(D) direito

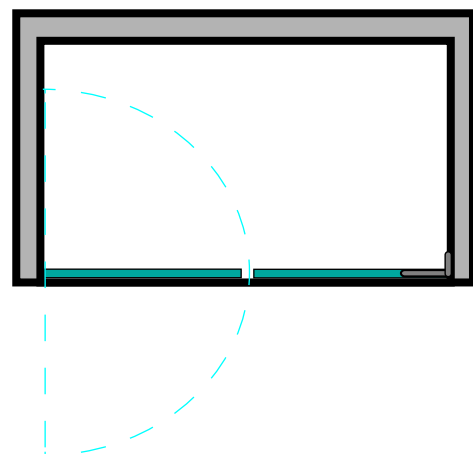
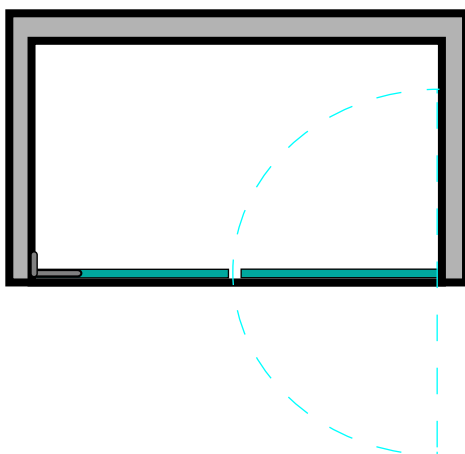

# DETALHES TÉCNICOS

PICTOGRAMAS



## MODELO D-411

(E) esquerdo

(D) direito

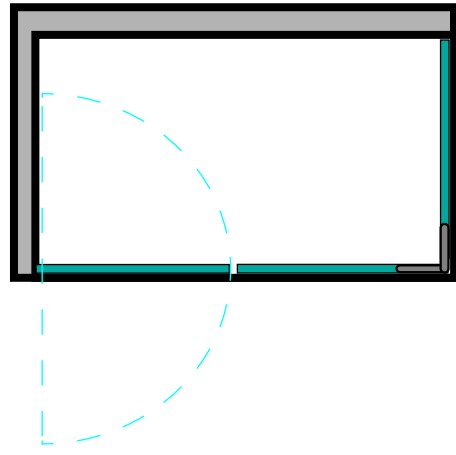
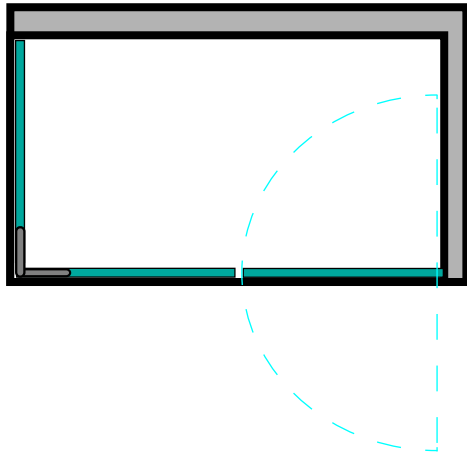

## MODELO D-416

(E) esquerdo

(D) direito

